

AR5000S - AR5010S

PRV : 50 - 1000 Volts
Io : 50 Amperes

FEATURES :

- * High current capability
- * High surge current capability
- * High reliability
- * Low reverse current
- * Low forward voltage drop
- * Pb / RoHS Free

MECHANICAL DATA :





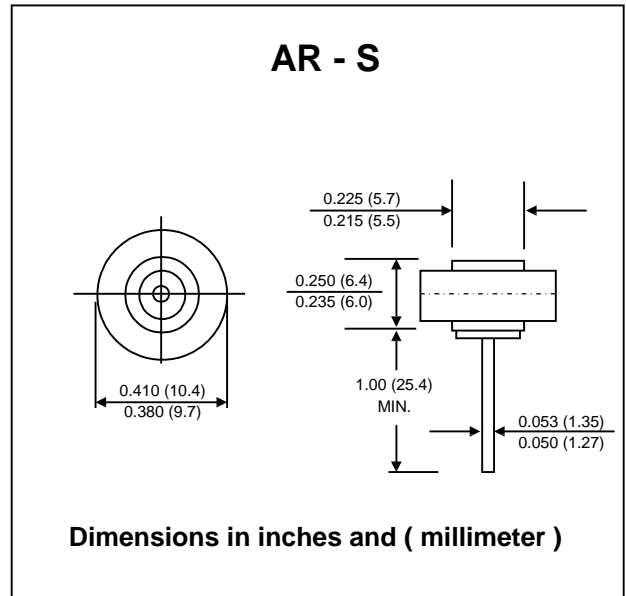

- * Case : Molded plastic
- * Epoxy : UL94V-O rate flame retardant
- * Terminals : Terminal are readily solderable
- * Polarity : Cathode polarity band
- * Mounting position : Any
- * Weight : 1.80 grams

AUTOMOTIVE RECTIFIER DIODES



MAXIMUM RATINGS AND ELECTRICAL CHARACTERISTICS

Rating at 25 °C ambient temperature unless otherwise specified.
 Single phase, half wave, 60 Hz, resistive or inductive load.
 For capacitive load, derate current by 20%.

RATING	SYMBOL	AR 5000S	AR 5001S	AR 5002S	AR 5004S	AR 5006S	AR 5008S	AR 5010S	UNIT
Maximum Repetitive Peak Reverse Voltage	V _{RRM}	50	100	200	400	600	800	1000	V
Maximum RMS Voltage	V _{RMS}	35	70	140	280	420	560	700	V
Maximum DC Blocking Voltage	V _{DC}	50	100	200	400	600	800	1000	V
Average Rectified Forward Current T _c = 150°C	I _{F(AV)}	50							A
Peak Forward Surge Current Single half sine wave superimposed on rated load (JEDEC Method)	I _{FSM}	500							A
Maximum Forward Voltage at I _F = 50 Amps.	V _F	1.1							V
Maximum DC Reverse Current Ta = 25 °C at rated DC Blocking Voltage Ta = 100 °C	I _R	5.0							µA
	I _{R(H)}	1.0							mA
Thermal Resistance (Note 1)	RθJC	0.8							°C/W
Junction Temperature Range	T _J	- 65 to + 175							°C
Storage Temperature Range	T _{STG}	- 65 to + 175							°C
Marking Code									

Note : (1) Thermal resistance from junction to case. Single side cooled.
 Page 1 of 2



RATING AND CHARACTERISTIC CURVES (AR5000S - AR5010S)

FIG.1 - DERATING CURVE FOR OUTPUT RECTIFIED CURRENT

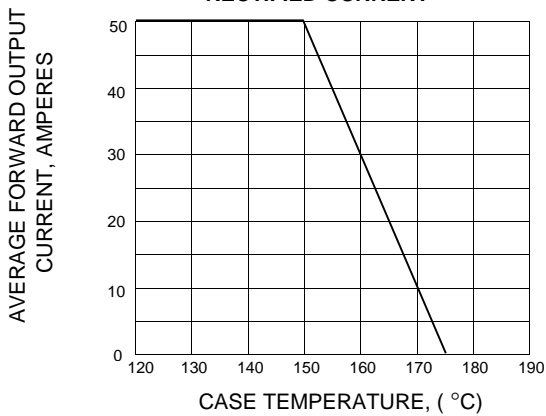

FIG.2 - MAXIMUM NON-REPETITIVE PEAK FORWARD SURGE CURRENT

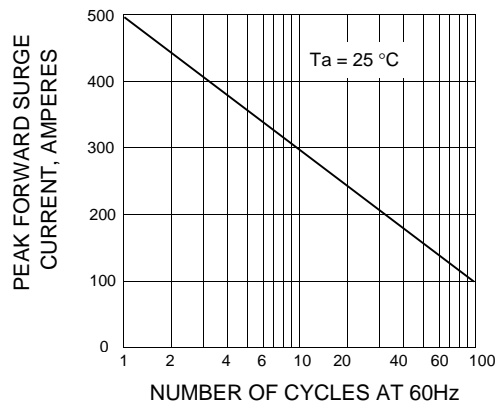

FIG.3 - TYPICAL FORWARD CHARACTERISTICS

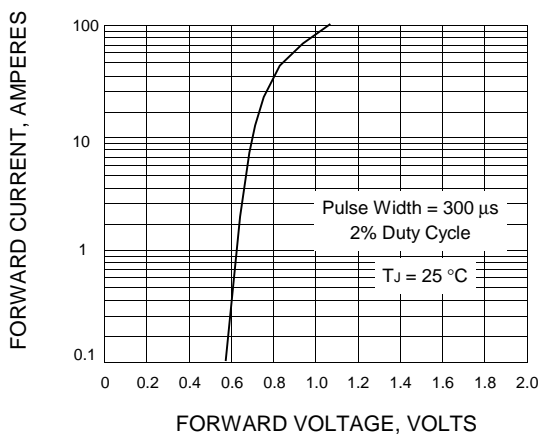

FIG.4 - TYPICAL REVERSE CHARACTERISTICS

